

**QUICK
EASY STEPS**
FOR SETTING UP YOUR PHONE!
SEE YOUR QUICK REFERENCE GUIDE SECTION

Uniden®



900MHz

DUAL HANDSET SYSTEM WITH INTEGRATED
DIGITAL ANSWERER AND CALLER ID/CALL WAITING

DXAI 388-2
OWNER'S MANUAL

www.uniden.com

Contents

Welcome/Features	2	Erasing a Stored Name and Phone Number	31
Quick Reference Guide	3	RocketDial	
Controls and Functions	4	RocketDial	32
Getting Started		Storing and Editing the RocketDial	32
Read this First	6	Making Calls with the RocketDial	32
Checking the Package Contents	7	Deleting the RocketDial	33
Setting up the Phone	8	Caller ID Features	
Before Using, Register Extra Handset to the Main Base Unit	12	Caller ID	34
When to Re-register Handsets	13	When the Telephone Rings	34
Call Transfer Feature	13	Viewing the Caller ID Message List	35
Mounting the Main Base Unit on a Wall	14	Deleting Information from the Caller ID List	36
Terminology	15	Using the Caller ID List	38
Setting Menu Options	16	The Integrated Answering Device	
Basics		The Integrated Answering Device	40
Making and Receiving Calls	19	Features	40
Adjusting the Handset Ringer and Earpiece Volume	20	Turning the Answering System On/Off	41
Redial	21	Setting Up Your Answering System	41
Tone Dialing Switch-over	21	Using Your Answering System	49
Traveling Out-of-Range	21	Additional Information	
Selecting a Different Channel	22	Changing the Digital Security Code	55
Page	22	Installing the Beltclip	55
Flash and Call Waiting	22	Headset Installation	55
Memory Dialing		Note on Power Sources	56
Storing Phone Numbers and Names	23	Maintenance	56
Steps for Entering Names and Special Characters	25	Troubleshooting	57
Making Calls with Memory Dialing	27	General Information	60
Chain Dialing	28	Precautions & Warranty	61
Editing a Stored Name and/or Phone Number	29	I.C. Notice	63
		Index	64
		Remote Operation Card	

Welcome

Congratulations on your purchase of the Uniden DXAI388-2 series cordless telephone. This phone is designed and engineered to exacting standards for reliability, long life, and outstanding performance.

Note: Some illustrations in this manual may differ from the actual unit for explanation purposes. The color of your cordless phone may vary.



As an ENERGY STAR® Partner, Uniden has determined that this product or product models meets the ENERGY STAR® guidelines for energy efficiency. ENERGY STAR® is a U.S. registered mark.

Features

- Dual Handsets
- 900 MHz Extended Range Technology
- 16 Digit, 3-line Backlit Display
- Integrated Telephone Answering Device (ITAD)
- Voice Prompted Guidance through ITAD Setup Menu
- 10 Number Memory Dialing (each handset)
- RocketDial (each handset)
- Caller ID and Call Waiting Caller ID (each handset)
- 30 Number Caller ID Memory
- 32 Digit Redial
- Flash and Pause
- Tone/Pulse Dialing
- Page/Find handset
- 7 Hour Talk Time/10 Day Standby Time
- Handset Earpiece and Ringer Volume Control
- Hearing Aid Compatible
- 20 Channel Autoscan
- Call Transfer

The DXAI388-2 series features include **AutoTalk™** and **AutoStandby™**. AutoTalk allows you to answer a call by just removing the handset from the main base so you don't have to waste time pushing buttons. AutoStandby allows you to hang up by simply returning the handset to the main base.

The **UltraClear Plus™** true compander circuitry virtually eliminates background noise. This innovative technology, together with 20 different channels, provides you with the best possible reception during all your conversations.

To protect you against misbilled calls which might result from your phone being activated by other equipment, the cordless phone has **Random Code™** digital security which automatically selects one of over 260,000 digital security codes for the handset and base. Also, the **AutoSecure™** feature electronically locks your phone when the handset is in the main base.

RocketDial™ is a one touch speed dial key that automatically dials your most important or frequently called number. The number dialed, is a preset number stored by the user.

Call Transfer allows you to transfer outside calls from handset to handset, only one handset at a time can talk with an outside caller.

Be sure to visit our web site: www.uniden.com

Uniden® is a registered trademark of Uniden America Corporation.

AutoTalk, AutoStandby, UltraClear Plus, Random Code, AutoSecure, and RocketDial are trademarks of Uniden America Corporation.

Step 1 Charging the Batteries

TO INSTALL THE HANDSET BATTERIES

- 1 Remove the cover.

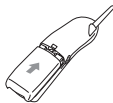

- 2 Connect the battery pack connector with the correct polarity.

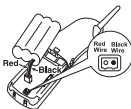

- 3 Replace the cover.

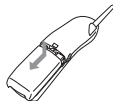

TO PLUG INTO AC POWER

- 1 Plug AC adapter cord into the main base unit and extra charging cradle and then into a 120V AC outlet. (Use only the supplied AD-420 AC adapter.)

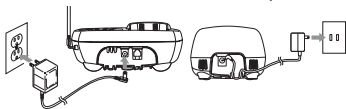

- 2 Place one handset on the main base and place the other handset in the extra charging cradle. It does not matter which handset is placed on the main base and extra charging cradle.

Note: You must charge the batteries continuously for 15 - 20 hours before using the phone.

Step 2 Connecting

CONNECT TO A PHONE LINE

When the handset battery pack is fully charged, after 15-20 hours of charging, plug the telephone cord into the main base unit and then into a telephone wall jack.

Your phone is set for tone dialing. If your local network requires pulse dialing, please see "Choose the dialing mode" on page 18.

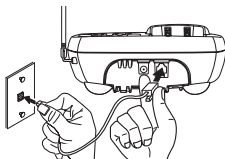

Step 3 Before Using, Register Extra Handset to Base

- 1 After fully charging the handsets, remove the handset from the extra charging cradle and place it on the main base. (Base status LED light will begin to flash indicating registration is occurring.)
- 2 Wait for at least 5 seconds before removing the extra handset from the main base.

Congratulations, the registration has been completed, and your dual handset cordless phone is ready for use!

Step 4 Setting Up the Caller ID

Note: Three Caller ID options are available: AutoTalk, Caller ID on Call Waiting (CIDCW), and Area Code.
Note: CIDCW can only be changed on HS1.

TO CHANGE CALLER ID OPTIONS

- 1 Press and hold *cid/menu*.
- 2 Press \wedge or \vee to move the pointer to an option.
- 3 Press *select/channel* to change the option setting.
- 4 Press *end* and return the handset to the main base.

Step 5 Setting Up the Answering System

TURN THE ANSWERING SYSTEM ON
Press *answer on/off*.

A pre-recorded greeting will play and your system is ready to accept calls.

TO RECORD A PERSONAL GREETING

- 1 Press and hold *greeting* until you hear "Record greeting" and a confirmation tone.
- 2 Record your personal greeting. (Position yourself as near to the main base as possible and speak clearly.)
- 3 When finished press *greeting* again or *play/stop*.

Controls and Functions

Dual Handsets

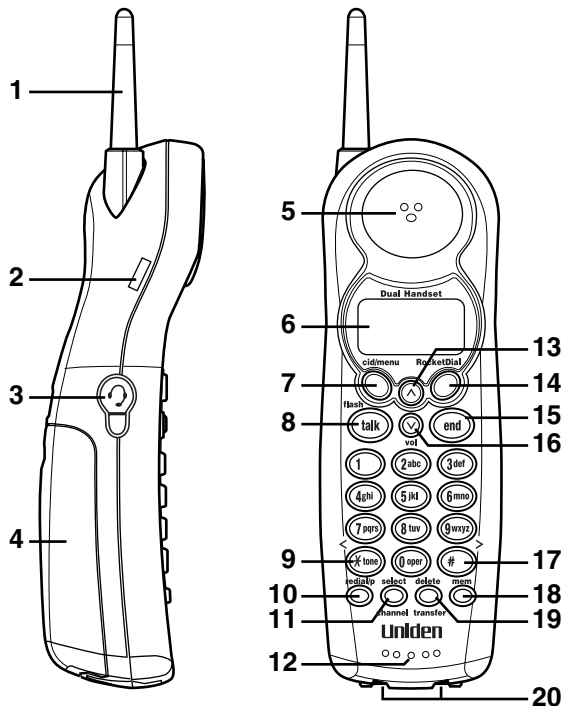

1. Handset antenna
2. Beltclip holes
3. Optional headset jack
4. Handset battery compartment
5. Handset earpiece
6. LCD display
7. Cid (caller ID)/menu key
8. Talk/flash key
9. * /tone/ < (left cursor) key
10. Redial/p (pause) key
11. Select/channel key
12. Handset microphone and ringer speaker
13. ^ (volume up) key
14. RocketDial key
15. End key
16. v (volume down) key
17. # / > (right cursor) key
18. Mem (memory) key
19. Delete/transfer key
20. Handset charging contacts

Main Base

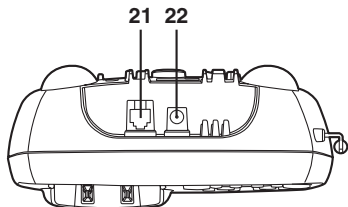

Extra Charging Cradle

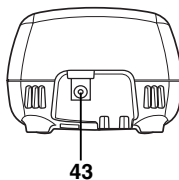
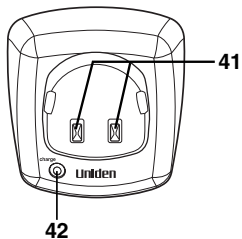
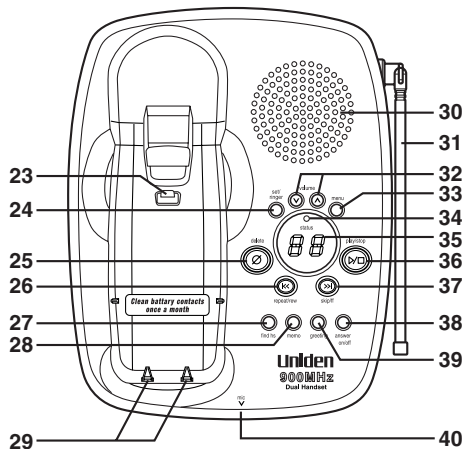

- 21. Telephone line jack
- 22. DC IN 9V jack
- 23. Handset retainer clip
- 24. Set/ringer key
- 25. Delete (Ø) key
- 26. Repeat/rew (rewind)(⏮) key
- 27. Find hs key
- 28. Memo key
- 29. Base charging contacts
- 30. Base speaker
- 31. Main base antenna
- 32. Speaker volume keys
- 33. Menu key
- 34. Status LED
- 35. Message counter display
- 36. Play/stop (▶/◻) key
- 37. Skip/ff (fast forward) (▶▶) key
- 38. Answer on/off key
- 39. Greeting key
- 40. Microphone
- 41. Charging contacts
- 42. Charge LED
- 43. DC IN 9V jack

Read this First

This cordless telephone must be set up before use. Follow these steps:

Step 1 (page 7)

Unpack the telephone and accessories.

Step 2 (page 8)

Next, choose the best location to set up the main base unit.



Step 3 (page 9 to 11)

Then, insert the battery packs into the handsets. Connect the main base unit and extra charging cradle. You must charge the battery packs for **15-20 hours before plugging into the telephone line and using the phone.**



Conveniently, your cordless phone allows you to transfer outside calls from handset to handset, simply by pressing the **transfer** key. Not to worry, conversations will not be interrupted; only one handset at a time can talk with an outside caller. The second handset cannot go off hook to listen to conversations or make an outgoing call while the other handset is in use.

Step 4 (page 12)

After fully charging the batteries, register the extra handset to the main base unit. Remove the handset from the extra charging cradle, then place it on the main base for at least 5 seconds while the base LED flashes. Registration should now be complete.

Step 5 (page 40 to 48)

Finally, set the answering system.

Checking the Package Contents

Make sure you have received the following items in the package. If any of these items are missing or damaged, contact the Uniden Parts Department.

- **Main base unit (1)**
- **Handset (2)**
- **AC adapter (AD-420)(2)**
- **Rechargeable battery (BT-905)(2)**
- **Telephone cord (1)**
- **Beltclip (2)**
- **Extra charging cradle (1)**
- **This owner's manual**
- **Other printed materials**

Uniden Parts Department at (800) 554-3988
Hours: M-F 7:00 a.m. to 5:00 p.m. CST. We can also be
reached on the web at www.uniden.com

Setting up the Phone

Do the following steps:

- A. Choose the best locations
- B. Install the battery packs
- C. Connect the main base unit and the extra charging cradle

A. Choose the best location

Before choosing a location for your new phone, read the **INSTALLATION CONSIDERATIONS** included in the **PRECAUTIONS AND IMPORTANT SAFETY INSTRUCTIONS** brochure. Here are some important guidelines you should consider:

Avoid heat sources, such as radiators, air ducts, and sunlight

Avoid television sets and other electronic equipment

Choose a central location

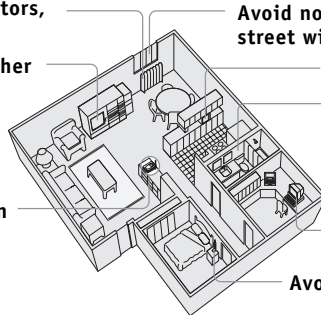

Avoid noise sources such as a window by a street with heavy traffic

Avoid microwave ovens

Avoid excessive moisture, extremely low temperatures, dust, mechanical vibration, or shock

Avoid personal computers

Avoid other cordless telephones

- The location should be close to both a phone jack and a continuous power outlet which is not switchable.
- Keep the main base and handsets away from sources of electrical noise such as motors, microwave ovens, and fluorescent lighting.
- The main base can be placed on a desk, tabletop, or mounted on a standard wall plate.

B. Install the battery packs

Charge the battery packs for at least 15-20 hours before plugging the phone line into your phone.

- 1) Press in on the battery cover release and slide the cover down until it comes off.
- 2) Connect the battery pack connector observing correct polarity (black and red wires) to the jack inside the battery compartment.

Do not exert any force on this connection. It could cause damage to the battery or to the handset. The plastic connectors will fit together in only one way. Once you are certain that you have made a good connection, then insert the battery pack into the battery compartment. Do not pinch the wires.

- 3) Securely close the battery compartment cover by sliding it up until it snaps into place.
- 4) Place the handset on the main base and the other in the extra charging cradle.

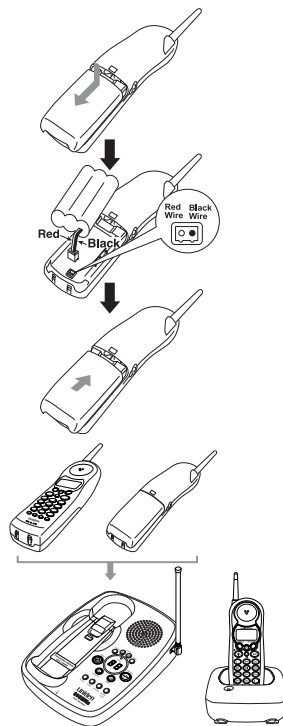

- Use only the Uniden battery (BT-905) supplied with your phone. Replacement batteries are also available through the Uniden Parts Department. (See page 7.)
- Place the extra handset in the charger with the keypad facing forward for 15-20 hours before use.



Even when the battery pack is not being used, it will gradually discharge over a long period of time. For optimum performance, be sure to return the handset to the main base unit after a telephone call.

Battery use time (per charge)

From fully charged (15-20 hours charge time)

- Seven hours continuous use
- Ten days when the handset is in the standby mode

Low Battery Alert

When the battery pack is very low and needs to be charged, the phone is programmed to eliminate functions in order to save power. If the phone is not in use, "Low Battery" appears on the LCD and none of the keys will operate.

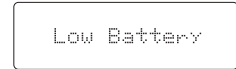

If the phone is in use, "Low Battery" flashes and the handset beeps. Complete your conversation as quickly as possible and return the handset to the main base unit for charging.



The last number dialed in the redial memory, the names and the numbers stored in the memory locations are retained for up to 30 minutes while you replace the battery pack.

Cleaning the Battery Charging Contacts

To maintain a good charge, it is important to clean the battery contacts on the handsets and main base unit as well as the extra charging cradle with a dry cloth or a pencil eraser about once a month.

Do not use any liquids or solvents.

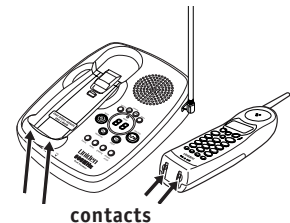

C. Connect the main base unit and the extra charging cradle

- 1) Connect the AC adapter to the DC IN 9V jack and to a standard 120V AC wall outlet. **Use only the supplied AD-420 AC adapter. Do not use any other AC adapter.**
- 2) Set the main base and extra charging cradle on a desk or tabletop, and place one handset on the main base unit and one in the extra charging cradle.
- 3) Raise the antenna to a vertical position.
- 4) Make sure that the **status** LED illuminates. If the LED does not illuminate, check to see that the AC adapter is plugged in and that the handset makes good contact with the main base charging contacts.

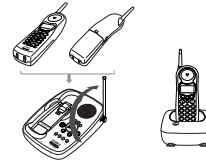
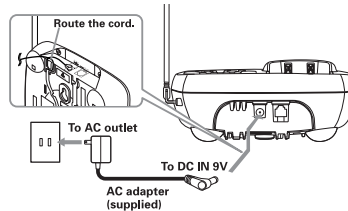

- note**
- Connect the AC adapter to a continuous power supply.
 - Place the main base unit close to the AC outlet so that you can unplug the AC adapter easily.
- After installing the battery packs in the handsets, charge your handsets at least **15-20 hours before plugging into the phone line.** Once the handsets battery packs are fully charged, connect the telephone line cord to the main base and telephone wall outlet.
- 5) Connect the telephone line cord to the **TEL LINE** jack and to a telephone outlet once the handset is fully charged.



If your telephone outlet isn't modular, contact your telephone company for assistance.



Modular

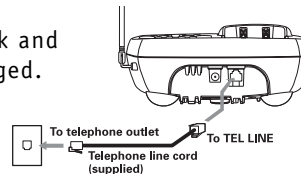

Place the power cord so that it does not create a trip hazard or where it could become chafed and create a fire or electrical hazard.



The handset can be placed face up or face down on the main base for charging.



- When you charge the handset, the Caller ID summary screen and the name of the handset, **HS1** appears. If **HS2** appears, you are charging the handset No.2.

		HS1
New	:01	
Total	:02	

- The smaller cradle is simply an extra charging device for either handset.

Before Using, Register Extra Handset to the Main Base Unit

The handset that is placed on the main base unit first will automatically be registered to the main base unit. (It does not matter which handset you choose to place on the main base unit first).

You will also need to register the extra handset by placing it on the main base. The extra handset **WILL NOT** operate properly until the registration has been completed. Once the handset is registered, it is ready for use.

Follow these simple steps to register:

- 1) First, install the battery packs in both handsets. Place either handset on the main base, then place the extra handset in the extra charging cradle. Charge both handsets **for 15-20 hours**.
- 2) After fully charging both batteries, remove the handset in the extra charging cradle, and place it on the main base. The **status** LED light on the main base will begin to flash, indicating that the registration is taking place between the extra handset and the main base.
- 3) Wait for at least 5 seconds before removing the handset from the main base.

Congratulations, the registration has been completed, and your dual handset cordless phone is ready for use!



- If the extra handset's battery becomes very low, the handset must be recharged for 15-20 hours and re-registered to the main base unit.
- Make sure to return the handsets to the charging cradles after each phone call.
- If you transfer the call and it is not picked up after 5 minutes, the call will be disconnected.

When to Re-register Handsets

- 1) You'll need to re-register the extra handset (follow steps on page 12) each time the digital security code is changed. Refer to page 55 for details regarding the Digital Security Code.
- 2) When there is a power failure for more than one hour
If power failure occurs (e.g. due to electrical storm or if the unit is unplugged during a move), both handsets will need to be re-registered. To re-register, follow the same registration process on page 12.

Call Transfer Feature

Conveniently, your cordless phone allows you to transfer outside calls from handset to handset, simply by pressing the **transfer** key. Not to worry, conversations will not be interrupted; only one handset at a time can talk with an outside caller. The second handset cannot go off hook to listen to conversations or make an outgoing call while the other handset is in use.

To transfer a call (to the second handset)

- 1) Press **delete/transfer** during a call. The call will automatically be placed on hold and the transfer tone sounds. To cancel the transfer, press **delete/transfer** or **talk/flash** on the handset.
- 2) When the other handset receives the call, the transfer tone stops.

Hold
Transfer Call

To receive a transferred call (from the second handset)

Pick up the handset (when AutoTalk is set to On), or pick up the handset and press **talk/flash** to answer the transferred call. Additionally, you can answer the transferred call by pressing any number key, ***/tone/ <**, or **#/ >** (when AutoTalk is set to On).

Transfer Call



DO NOT use an AC outlet controlled by a wall switch.

Mounting the Main Base Unit on a Wall

Standard wall plate mounting

This phone can be mounted on any standard wall plate.

- 1) Plug the AC adapter into the **DC IN 9V** jack.
- 2) Route the AC adapter cord through the molded wiring channel as shown.
- 3) Plug the AC adapter into a standard 120V AC wall outlet.
- 4) Plug the telephone line cord into the **TEL LINE** jack. Route the cord through the molded wiring channel as shown.
- 5) Plug the telephone line cord into the telephone outlet.
- 6) Align the mounting slots on the main base with the mounting posts on the wall. Then push in and down until the phone is firmly seated.

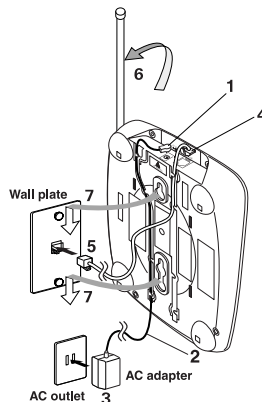

Direct wall mounting

If you don't have a standard wall plate, you can mount your phone directly to the wall. Before doing this, consider the following:

- Avoid electrical cables, pipes, or other items behind the mounting location that could cause a hazard when inserting screws into the wall.
- Try to mount your phone within 5 feet of a working phone jack to avoid excessive lengths.
- Make sure the wall material is capable of supporting the weight of the main base and handset.
- Use #10 screws (minimum length of 1-3/8 inches) with anchoring devices suitable for the wall material where the main base unit will be placed.

1) Insert two mounting screws into the wall, (with their appropriate anchoring device), 3-15/16 inches apart. Allow about 1/8 of an inch between the wall and screw heads for mounting the phone.

2) Refer to steps 1 through 6 on page 14 to mount the telephone.

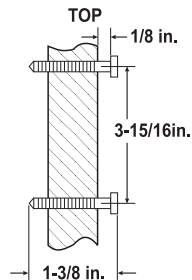

Terminology

Throughout this manual, terms such as Standby and Talk Mode are used. Below is the terminology explanation.

- **Standby Mode** - The handset is not in use, off the main base or extra charging cradle, and *talk/flash* has not been pressed. A dial tone is not present.
- **Talk Mode** - The handset is off the main base or extra charging cradle and *talk/flash* has been pressed enabling a dial tone.



If your calling area requires 10-digit dialing, do not program this option.

Setting Menu Options

There are four setup options available. They are Caller ID options [AutoTalk, CIDCW (Caller ID on Call Waiting), Area Code] and Dial Mode.

AutoTalk allows you to answer the phone without pressing the **talk/flash** button. If the phone rings when AutoTalk is on, simply remove the handset from the main base and the phone automatically answers the call. If the phone rings when AutoTalk is off, you must press **talk/flash** to answer the call.

CIDCW and Dial Mode options can only be set by using Handset 1. If you try to set by using Handset 2, you will not see these options listed on the LCD screen.

To confirm which handset is HS1, refer to the display indicating "HS1" or "HS2".

AutoTalk and Area Code options can be set by using either Handset 1 or Handset 2. Refer to the following screen.

```
1▶Auto Talk:Off
2 Area Code:
```

Caller ID options

To change your AutoTalk and CIDCW:

1) Press and hold **cid/menu**. The following screen appears.

```
1▶Auto Talk:Off
2 CIDCW      :On
3 Area Code:
```

2) Use **^** and **v** or a number key (1 and 2) to move the pointer to the selection that you would like to change.

Press **select/channel** to toggle between "On" and "Off" for AutoTalk and CIDCW.

3) Press **end** and return the handset to the main base unit. The handset returns to the standby mode.

To enter your Area Code

If you enter a 3-digit area code number in the *Area Code* option, your local area code does not appear in Caller ID messages. Do not program this option, if your calling area requires 10-digit dialing.

When reviewing Caller ID messages, you will see only the local seven digit number. For calls received from outside your local area code, you will see a full 10-digit number.

1) When the phone is in the standby mode, press and hold ***cid/menu***. The Caller ID setting screen appears.

```
1▶ Auto Talk:Off
2 CIDCW      :On
3 Area Code:
```

2) Press **3** or press **▼** twice to select "Area Code".

```
1 Auto Talk:Off
2 CIDCW      :On
3▶ Area Code:
```

3) Press ***select/channel***.

```
1 Auto Talk:Off
2 CIDCW      :On
3 Area Code:█
```

4) Use the number keys (**0** to **9**), **#/ >**, ***/tone/ <** or ***delete/transfer*** to enter the 3-digit area code.

5) Press ***select/channel***. A confirmation tone sounds and the displayed area code is entered.

6) Press ***end*** or return the handset to the main base unit. The handset returns to the standby mode.

When the area code has already been stored in memory, the stored area code will be displayed. To change it, use the ***delete/transfer*** and number keys to enter the new area code.

Then press ***select/channel***. A confirmation tone sounds. To complete the setting, press ***end*** or return the handset to the main base unit.

```
1 Auto Talk:Off
2 CIDCW      :On
3 Area Code:817
```





- Make sure your battery pack is fully charged before choosing the dial mode.
- Dialing mode can only be changed from handset 1. To confirm which handset is HS1, look at the display indicating "HS1" or "HS2".

Choosing the dialing mode

Most phone systems use tone dialing which sends DTMF tones through the phone lines. However some phone systems still use pulse dialing such as in rural areas. The default setting is tone dialing. Depending on your dialing system, set the mode as follows:

1) When the phone is in the standby mode, press and hold **cid/menu**. The following screen appears.

```
1▶ Auto Talk: Off
2 CIDCW      : On
3 Area Code:
```

2) Press **4** or press **▼** three times to select "Dial".

```
2 CIDCW      : On
3 Area Code:
4▶ Dial      : Tone
```

3) Press **select/channel** to toggle between "Tone" and "Pulse" for each setting.

4) Press **end** and return the handset to the main base unit. The handset returns to the standby mode.



- If you are not sure of your dialing system, set for tone dialing. Make a trial call. If the call connects, leave the setting as is, otherwise set for pulse dialing.
- If your phone system requires pulse dialing and you need to send the DTMF tones for certain situations during a call, you may "switch-over" to tone dialing. (Refer to "Tone Dialing Switch-over" on page 21.)

Making and Receiving Calls



Refer to page 16 "Setting Menu Options" to turn on the AutoTalk feature if desired.

	Handset On Base	Handset Off Base
To answer a call	Pick up the handset (AutoTalk: On) or pick up the handset and press talk/flash (AutoTalk: Off).	Press talk/flash , any number, */tone/ < or #/ > (AutoTalk: On).
To make a call	<ol style="list-style-type: none"> 1) Pick up the handset. 2) Press talk/flash. 3) Listen for the dial tone. 4) Dial the number. <p style="text-align: center;">OR</p> <ol style="list-style-type: none"> 1) Pick up the handset. 2) Dial the number, then press talk/flash. 	<ol style="list-style-type: none"> 1) Press talk/flash. 2) Listen for the dial tone. 3) Dial the number. <p style="text-align: center;">OR</p> <p>Dial the number, then press talk/flash.</p>
To hang up	Press end , or return the handset to the main base or extra charging cradle (AutoStandby).	
To redial	<ol style="list-style-type: none"> 1) Pick up the handset. 2) Press talk/flash. 3) Listen for the dial tone. 4) Press redial/p. <p style="text-align: center;">OR</p> <ol style="list-style-type: none"> 1) Pick up the handset. 2) Press redial/p, then press talk/flash. 	<ol style="list-style-type: none"> 1) Press talk/flash. 2) Listen for the dial tone. 3) Press redial/p. <p style="text-align: center;">OR</p> <p>Press redial/p, then press talk/flash.</p>

Adjusting the Handset Ringer and Earpiece Volume





If you select “Ringer Off”, “<Ringer Off>” appears on the display when you make or receive calls, or charging the handset.

Handset ringer tone and volume

Press \wedge or \vee in standby mode to select one of five ringer tones and volume combinations.

Earpiece volume

Pressing \wedge or \vee during a call will change the earpiece volume of the handset. This setting will remain in effect after the telephone call has ended.

Volume Maximum  Volume High  Volume Medium  Volume Low



When you press \wedge in Maximum mode or \vee in Low mode, the handset beeps rapidly.

Ringer Mute

You can temporarily mute the ringer tone. (The main base unit will continue to ring.) When receiving an incoming call, press **end** on either handset to stop the ringing. The handsets will ring beginning with the next incoming call.

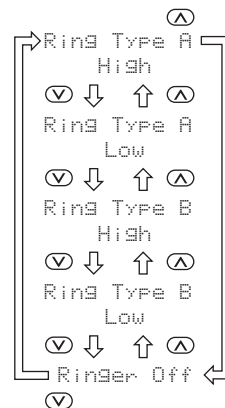

Redial

The **redial/p** key redials the last number dialed. The redialed number can be up to 32 digits long.

Tone Dialing Switch-over

Some telephone companies use equipment that requires pulse dialing (sometimes referred to as rotary dialing). If you need to enter tone dialing digits, you can switch-over to tone dialing during the call. For example, entering your bank account number after you have called your bank.

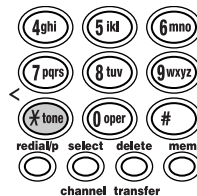

Initially make your call with the pulse dialing mode. Once your call connects, press ***/tone/ <**. Enter the desired number. These digits will be sent as tone dialing. Once the call ends, the tone mode is canceled and pulse dialing mode resumes.

Traveling Out-of-Range

During a call, as you begin to move your handset too far from your main base unit, noise increases. If you pass the range limits of the main base unit, your call will terminate within 5 minutes.



- The tone feature only applies when the dial mode is set to pulse.
- This special number can be stored in a memory location. This is referred to as Chain Dialing (See page 28.)



- You can change the phone's channel by pressing the **select/channel** key on either handset.

Selecting a Different Channel

If you encounter interference while using your phone, you can manually change the phone's channel for clear operation. This function works only when the phone is in use.

Press **select/channel**. "Scanning" appears on the display, indicating the phone is changing to another channel. For more information on interference, refer to "Precautions" on page 61.

Page

To locate the handset (while it's off the main base), press **find hs** on the main base. Both handsets beep for 60 seconds.

Paging of both handsets is canceled when pressing any key on either handset and **find hs** on the main base.

- Paging is also canceled when the phone receive a incoming call.

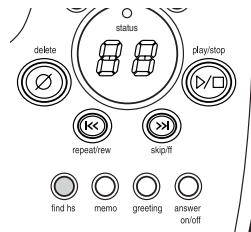

Flash and Call Waiting

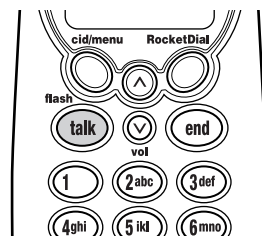

If you have "Call Waiting" service and a call waiting tone sounds while you are on a call, press **talk/flash** to accept the waiting call. There is a short pause, then you will hear the new caller. To return to the original caller, press **talk/flash** again.



You must subscribe through your local telephone company to receive Call Waiting Service.

Storing Phone Numbers and Names

Memory Dialing allows you to dial a number using just a few key presses. Your cordless phone stores 10 names/numbers in each handset.

1) Press and hold **mem** until "Memory Store" is displayed.

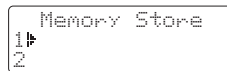

2) Press **▲** or **▼**, or enter a number (0 - 9) to select the memory location where you would like to store the number.

3) Press **select/channel**. The following screen appears and a cursor flashes indicating that the display is ready for the name to be entered.

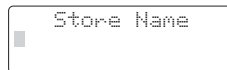

If this screen appears, the selected memory location is already stored. Then you must either edit the entry in this location (See page 29), delete the entry in this location (See page 31), or select "Go Back" to choose another location.

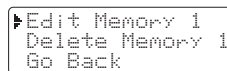

4) To enter a name (up to 14 characters), use the number keys.

- See the "Steps for entering names and special characters". (See pages 25-26)
- Use **#/ >** and ***/tone/ <** to move the cursor to the desired location.
- Use **delete/transfer** to delete characters as needed.
- Press and hold **delete/transfer** to delete all the characters.
- If a name is not required, go to step 5.



- In memory dialing operation, you must press a key within 30 seconds. Otherwise, an error tone will sound and the phone will return to standby. If you return the handset to the base, the phone will return to standby also.
- Memory locations are independent of each other.



- The pause feature is useful for long distance calling, credit card dialing, or sequences that require a pause between digits.
- Pressing *redial/p* more than once increases the length of a pause between numbers.
- The 10 memory locations are represented by the numbers 0-9 on the keys. If you store a number in one of the locations, then attempt to store a different number in the same location later, the new number will overwrite the previous one.

5) Press *select/channel*. "Store Number" is displayed.
The cursor flashes indicating that the display is ready for the number to be entered.

```
Store Number
█
```

6) Use the number keys to enter the phone number.
The phone number cannot exceed 20 digits.
Use *redial/p* to enter a pause in the dialing sequence.
The display shows a "P". Each pause counts as one digit and represents a two second delay of time between the digits.
Use *delete/transfer* to delete digits as needed.

```
Store Number
8002971023█
```

7) Press *select/channel*. You will hear a confirmation tone, and the following screen appears. Memory storage is complete.

```
Memory 7 Stored
```

For example, if you store a name and number into memory location number 7, the display shows
"Memory 7 Stored".

```
Memory Store
7▶UNIDEN CORP
8 <Memory 8>
```

After about 2 seconds, "Memory Store" is displayed. Repeat steps 2 - 7 to store more numbers.

8) Press *end* to return to standby mode.

Steps for Entering Names and Special Characters

Refer to the letters on the number keys to select the desired characters.

With each press of a numeric key, the displayed character appears in the following order: Upper case letters first, lower case letters next and finally the number corresponding to the key.

	Number of times key is pressed								
keys	1	2	3	4	5	6	7	8	9
1	1								
2abc	A	B	C	a	b	c	2		
3def	D	E	F	d	e	f	3		
4ghi	G	H	I	g	h	i	4		
5jkl	J	K	L	j	k	l	5		
6mno	M	N	O	m	n	o	6		
7pqrs	P	Q	R	S	P	q	r	s	7
8tuv	T	U	V	t	u	v	8		
9wxyz	W	X	Y	Z	w	x	y	z	9
0	*	#	-	&	()	(blank)	0	

If you make a mistake while entering a name

Use ***/tone/ <** or ***/tone/ >** to move the cursor to the incorrect character. Press **delete/transfer** to erase the wrong character, then enter the correct character. To delete all characters, press and hold **delete/transfer**.

For example, to enter **Uniden**;

- 1) Pick up the handset and press and hold *mem*.
- 2) Enter a number or press **^**, **v** to select a memory location number.
- 3) Press *select/channel*.
- 4) Press **8** twice.
- 5) Press **6** five times.
- 6) Press **4** six times.
- 7) Press **3** four times, then press **#/ >** to move the cursor to the right.



If the next character uses the same number key, you must press **#/ >** to move the cursor over. Otherwise the next time you press the number key, it changes the character that was previously set.

- 8) Press **3** five times.
- 9) Press **6** five times.
- 10) When finished, press *select/channel*.

To continue to store the telephone number, proceed to step 6 on page 24.

Making Calls with Memory Dialing

Memory dialing from Standby Mode

1) Press **mem**.

The handset displays your programmed memory locations.

```
1 UNIDEN CORP
2 JOHN DOE
3 MOM AND DAD
```

2) Press **∨** or **∧**, or enter the number (0 - 9) to select the memory location you would like to dial.

3) Press **talk/flash**. "Connecting" and the number you would like to dial appear on the display. Then the displayed number is dialed.

```
>Connecting<
0123456789012
```

Display a Programmed Number

Use **#/>** and ***/tone/<** to toggle between the names display and the numbers display.

Program name

Program number

```
1 UNIDEN CORP
2 JOHN DOE
3 MOM AND DAD
```



```
1 8002971023
2 5452930
3 8175551212
```

note

When the stored phone number has 15 or more digits, "→" is displayed next to the 13th digit. Press **#/>** to see the extra digits and ***/tone/<** to return.

```
5 012345678901
6 →0118135543290→
7
```

note

- If you press **select/channel** before **talk/flash**, you can confirm the name and the number stored in the selected memory location.
- To exit the memory dialing function without dialing, press **end**. The handset returns to standby.
- Whenever you are using a memory menu screen, you must press a key within 30 seconds or the phone will return to standby.



If you select a memory location that does not have a stored number, an error tone sounds and the phone will not dial.

Memory dialing from Talk Mode

1) Press *talk/flash*. "Connecting" appears.

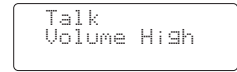
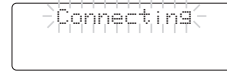

2) After the display changes from "Connecting" to "Talk", press *mem*.



3) Enter a number (0 - 9) to select the memory location of the desired phone number. The selected phone number is displayed. Then the number is dialed.



4) To hang up, press *end*.

Chain Dialing

The memory locations on the handset are not limited to phone numbers. You can also store a group of numbers (up to 20 digits) that you need to enter once your call connects. This is referred to as Chain Dialing.

An example of this is a bank account number. Once you have called your bank, and are prompted to enter the account number, simply press *mem* and the location number where the special number has been stored.

Store your special number with an identifying name. (Refer to "Storing Phone Numbers and Names" on page 23.)

Editing a Stored Name and/or Phone Number

- 1) Press and hold **mem** until "Memory Store" is displayed.
- 2) Press **^** or **v**, or enter a number (0 - 9) to select the memory location you would like to edit.
- 3) Press **select/channel**.
The following screen appears with the memory location number that you have selected in the display.
- 4) Press **^** or **v** to select "Edit Memory", then press **select/channel**. The following screen appears. The cursor flashes indicating that the display is ready for the name to be edited. When a name has not been stored, the cursor appears at the beginning of the second line.
- 5) Use the number keys, ***/tone/ <**, **#/ >**, or **delete/transfer** to edit the name. (See page 23.)
To edit only the phone number, skip this step.
- 6) Press **select/channel**. The following screen appears.
The cursor flashes indicating that the display is ready for the number to be edited.

```
Memory Store
1 UNIDEN CORP
2 JOHN DOE
```

```
Edit Memory 2
Delete Memory 2
Go Back
```

```
Store Name
UNIDEN CORP
```

```
Store Number
8002971023
```

- 7) Use the number key, *redial/p* or *delete/transfer* to edit the phone number.
The phone number cannot exceed 20 digits. (See page 24.)
If you don't want to change the phone number, skip this step.
- 8) Press *select/channel*. You hear a confirmation tone, and the following screen appears. The memory storage is complete.
For example, if you store a name and number into memory location number 1, the display shows "Memory 1 Stored".
After about 2 seconds, "Memory Store" is displayed.
- 9) Press *end* to return to standby mode.

A rectangular box representing a screen display with the text "Memory 1 Stored" in a monospaced font.

Memory 1 Stored

A rectangular box representing a screen display with the text "Memory Store" followed by two lines of data: "1▶UNIDEN CORP" and "2 JOHN DOE".

Memory Store
1▶UNIDEN CORP
2 JOHN DOE

Erasing a Stored Name and Phone Number

- 1) Press and hold **mem** until "Memory Store" is displayed.
- 2) Press **▲** or **▼**, or enter a number (0 - 9) to select the memory location you would like to erase.
- 3) Press **select/channel**.
The following screen appears with the memory location number that you have selected in the display.
- 4) Press **▼** to move the pointer down to "Delete Memory".
- 5) Press **select/channel**. The following confirmation screen appears.
- 6) Press **▲** to move the pointer to "Yes".
- 7) Press **select/channel** or **delete/transfer**.
You hear a confirmation tone, and the following screen appears.
- 8) After about 2 seconds, the display returns to the "Memory Store" screen.
You may delete the information in another memory location (return to step 2) or press **end** to return to standby mode.

```
Memory Store  
1 UNIDEN CORP  
2 JOHN DOE
```

```
Memory Store  
1 UNIDEN CORP  
2 JOHN DOE
```

```
Edit Memory 2  
Delete Memory 2  
Go Back
```

```
Edit Memory 2  
Delete Memory 2  
Go Back
```

```
Delete Memory 2?  
Yes  
No
```

```
Memory 2 Deleted
```

```
Memory Store  
2 MOM AND DAD  
3
```



- Memory location for the RocketDial is independent from the memory location for Memory dial.

- If the RocketDial does not have a stored number, an error tone sounds and the phone will not dial.

RocketDial

You can store your most frequently dialed number in the RocketDial location in each handset. The RocketDial allows you to dial a number with one key press. (There is no need to press *talk/flash*. The phone will automatically dial the number stored.)

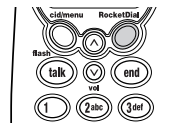

Storing and Editing the RocketDial

- 1) When the phone is in the standby mode, press and hold **RocketDial**. Following display appears.
If this screen appears, there is a number already stored. Press **^** or **v** to select "Edit Number", then press *select/channel*.
- 2) Store the number by following step 6 under "Storing Phone Numbers and Names" on page 24.
- 3) Press *select/channel*.
You hear a confirmation tone, and the following screen appears. Memory storage is complete.

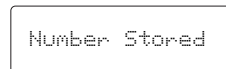
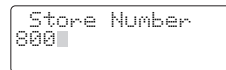
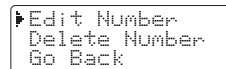
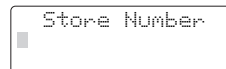

Making Calls with the RocketDial

When the phone is in the standby mode, simply press **RocketDial**. The number stored in the RocketDial memory location is instantly dialed.

Deleting the RocketDial

- 1) When the phone is in the standby mode, press and hold **RocketDial**. Following display appears.
- 2) Press **▲** or **▼** to select "Delete Number".
- 3) Press **select/channel**. Following display appears.
- 4) Press **▲** to move the pointer to "Yes".
- 5) Press **select/channel** or **delete/transfer**.
You hear a confirmation tone, and the following display appears. After about 2 seconds, the handset returns to standby mode.

```
▶ Edit Number
Delete Number
Go Back
```

```
Delete Number?
Yes
▶ No
```

```
Number Deleted
```



- If you answer a call before the Caller ID message is received (Example: before the second ring), the Caller ID message will not appear.
- When the call is received via a telephone company that does not offer Caller ID service, the caller's phone number and name do not appear. (This includes international calls.)
- When the call is via a private branch exchange (PBX), the caller's phone number and name may not appear.

Caller ID

You must subscribe to Caller ID service to use this feature.

When the telephone rings, the Caller ID feature allows you to view the caller's name and phone number on the display before you answer the phone.

The handset displays the phone number of the incoming call, the name, and time. Additionally, you can dial the displayed number and store the information for memory dialing.

Make sure you have turned on the Caller ID/Call Waiting feature. (See page 16.)

When the Telephone Rings

- 1) When the Caller ID message is received, the display shows the caller's phone number along with the date and time. The incoming call information is stored in the Caller ID record. If the Caller ID service includes the caller's name, the caller's name appears on the display (up to 15 letters).

The date and time received — 5/11 12:30PM
Caller's name — UNIDEN CORP
Caller's phone number — 800-297-1023

Here are some typical displays;

When the phone number and name data are received

5/11 12:30PM
UNIDEN CORP
800-297-1023

When invalid data is received

Incomplete Data

When a private name is received

5/11 12:30PM
Private Name
800-297-1023

When a private number is received

5/11 12:30PM
UNIDEN CORP
Private Number

When an unknown name is received When an unknown number is received

```
5/11 12:30PM
Unknown Name
800-297-1023
```

```
5/11 12:30PM
UNIDEN CORP
Unknown Number
```

2) When you pick up the phone, the display changes to "Connecting". (AutoTalk feature is set to on.)



Data errors appear as "■".

Viewing the Caller ID Message List

The Caller ID list stores information for up to 30 incoming calls in each handset - even unanswered calls.

1) Press **cid/menu**.

The summary screen appears.

The screen shows the number of new messages and total messages.

```
New :01
Total:02
```

2) Press **▼** to display the latest Caller ID message.

```
5/17 12:30PM 03
UNIDEN CORP
800-297-1023
```

3) Press **▼** to see the next message. Or press **▲** to see previous message.

4) Press **end** to return to standby mode.



- In Caller ID operation, if no key is pressed for more than 30 seconds, an error tone sounds and the telephone returns to the standby mode.
- If a call comes in via a telephone system that does not offer Caller ID service, no information is stored.
- Each message can be up to 15 characters for the phone number and the name.
- The number of calls from the same Caller ID appears next to the received time. Once you read the new message, the number will clear and disappear.



- While using the "Delete All?" or "Delete Message?" screen if no key is pressed for more than 30 seconds, an error tone sounds and the telephone returns to standby.
- If you get an incoming call, a transferring call or page, the deleting operation is canceled and you can answer the call or page.

Deleting Information from the Caller ID List

The cordless phone stores up to 30 messages in each handset. If the phone receives the 31st message, the oldest one in the list is automatically deleted. Caller ID data can also be deleted manually.

Deleting a Caller ID message

(The Caller ID list in each handset are independent of one another.)

- 1) Press **cid/menu**. Display the message to be deleted from the Caller ID list by pressing **▲** or **▼**.
- 2) Press **delete/transfer**.
- 3) Press **▲** or **▼** to select "Yes" or "No".
- 4) Press **select/channel** or **delete/transfer**.

```
5/17 12:30PM 03
UNIDEN CORP
800-297-1023
```

```
Delete Message?
▶ Yes
No
```

When the pointer is at "Yes":

A confirmation tone sounds and the Caller ID message is deleted. The next Caller ID message is then displayed.

When the pointer is at "No":

The display returns to the Caller ID message.

Deleting all Caller ID names/numbers

- 1) Press **cid/menu**.
- 2) Press **delete/transfer**.

```
New :01
Total:02
```

3) Press **▲** or **▼** to select "Yes" or "No".

```
Delete All?  
  Yes  
  No
```

4) Press **select/channel** or **delete/transfer**.

When the pointer is at "Yes":

A confirmation tone sounds and all stored Caller ID messages are deleted.

```
Total:00
```

When the pointer is at "No":

The display returns to the summary screen.

```
New :01  
Total:02
```



- You cannot make a call from the Caller ID list if your cordless phone connected to private branch exchange (PBX).
- When a long distance call has been set, "1" appears in the display.

Using the Caller ID List

Calling a party from the Caller ID list

You can place a call from the Caller ID list. The cordless phone stores up to 30 messages in each handset.

- 1) Press ***cid/menu***. Select the phone number that you want to dial by pressing **▲** or **▼**.
- 2) Press ***talk/flash***. The displayed phone number dials automatically.

```
5/17 12:30PM 03
UNIDEN CORP
800-297-1023
```

```
>Connecting<
8002971023
```

Long Distance calls and Area Code Setting/Cancellation

Pressing **1** while the incoming Caller ID information is displayed (in step 1) will place the prefix "1" in the display to set up for a long distance call. Pressing **3** will set or cancel an area code setting.

Dial edit

You can temporarily edit the Caller ID number that is displayed by pressing ***select/channel***. A cursor appears in the display. Press ***delete/transfer*** to move the cursor left, enter the new phone number you would like to dial and then press ***talk/flash***. This will not change the number in the Caller ID list memory.

Storing Caller ID messages in Memory dialing

Messages shown in the Caller ID list can be stored in memory dialing.

Using the incoming call information (i.e., Caller ID list), the phone number of the party on the Caller ID list can be stored in memory.

1) Press ***cid/menu***.

Select the phone number to be stored from the Caller ID list by pressing **▲** or **▼**.

```
5/17 12:30PM 03
UNIDEN CORP
800-297-1023
```

2) Press ***mem***.

```
Select Location
1
2 JONE DOE
```

3) Press **▲** and **▼** or enter a number (0 - 9) to select the memory location to be stored.

4) Press ***select/channel***.

You hear a confirmation tone, and the number is stored in memory.

The display returns to the Caller ID list.

```
5/17 12:30PM 03
UNIDEN CORP
800-297-1023
```



If a message has already been stored in the selected memory number location, a confirmation screen is displayed. Press **▲** to select "Yes". Press ***select/channel*** to overwrite. The display returns to the Caller ID list.

```
Replace Memory?
Yes
No
```



You can not store a Caller ID message if no phone number appears in the message.

The Integrated Answering Device

The cordless phone has a built-in answering system that answers and records incoming calls. You can also use your answering system to record a conversation, leave a voice memo message, or to announce a special outgoing message to callers when you're away from your phone.

Features

- Digital Tapeless Recording
- 13 minutes of Recording Time
- Call Screening
- Selectable Outgoing Messages
- Voice Prompts for Guidance
- Time and Day Announcement
- Remote Message Retrieval
- Toll Saver
- Conversation Recording
- Voice Memo

Digital Tapeless Recording allows you to quickly review, save, or delete the messages you choose. You will never have to worry about a tape wearing out, jamming, or resetting improperly.

The Integrated Answering System is easy and convenient to use, but **please read** through all of the instructions carefully.

Turning the Answering System On/Off

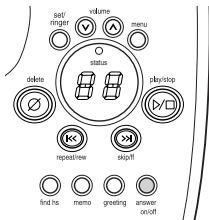

- 1) To turn the answering system on, press **answer on/off**.
The current greeting message will be played and you will hear a confirmation tone. The message counter displays the number of messages stored in memory. If the display flashes, then there are new messages waiting for you.
- 2) To turn the answering system off, press **answer on/off** again.
After the announcement "Answer off" the message counter display will no longer be illuminated.

Setting up Your Answering System

Using the Menu Mode

The Menu mode allows you to set the following Answering System functions.

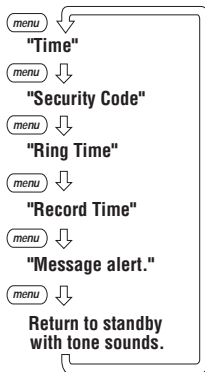

- To scroll through the menu options, repeatedly press **menu**. The system returns to standby after the last menu option. You hear a confirmation tone to indicate standby mode.
- If any of the following occurs during menu setup, the system returns to standby. Start over with the menu function prior to the interruption.
 - Press **talk/flash**
 - Press **play/stop**
 - 30 seconds lapse of time
 - Receive a call
- The idle time default setting is 30 seconds. If the main base remains idle for 30 seconds, an error tone sounds and the system returns to standby.
- You can use volume **^/∇** to adjust the announcement volume level during a voice prompt/guidance.



- For your convenience, voice prompts will guide you through the menu mode.
- After the setting, press **play/stop** to exit the menu mode, or **menu** to move to the next menu option. Or the system automatically returns to standby in 30 seconds after the setting.



- Normally the idle time for the menu mode is 30 seconds before the system returns to standby. However for setting the time, the idle time is extended to two minutes.
- Press and hold **skip/ff** or **repeat/rew** to quickly scroll through the numbers on the display.

Setting the Time

The clock on the cordless phone answering system starts when power is supplied to the main base. Follow these steps to set the clock to the correct time.

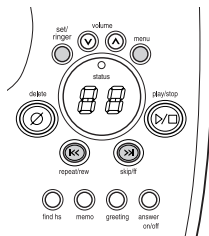

- 1) Press **menu**.
The system announces “Time” and the current time. The message counter displays the current numbers ([/] through [7]) indicating the day of the week.
- 2) Press **skip/ff** or **repeat/rew** until the correct day is announced. The numbers [/] through [7] are displayed on the main base.
- 3) Press **set/ringer** to select the day.
- 4) Press **skip/ff** or **repeat/rew** until you hear the correct hour setting. The numbers [/] through [/2] are displayed on the main base as each hour is announced.
- 5) Press **set/ringer** to select the hour.
- 6) Press **skip/ff** or **repeat/rew** until you hear the correct minute setting. The numbers [00] through [59] are displayed on the main base as each minute is announced.

- 7) Press **set/ringer** to select the minute.
- 8) Press **skip/ff** or **repeat/rew** until you hear the correct AM or PM setting. The message counter displays [R] or [P].
- 9) Press **set/ringer** to select the AM/PM setting.

You hear a confirmation tone, then the announcement “Time” and the time and day are announced for your review. The main base message counter displays the number that corresponds with the day of the week.

Setting a Personal Security Code (PIN)

To play your messages from a remote location, you will need to enter a two-digit Personal Identification Number (PIN) code (00-99). To select a PIN, perform the following steps:

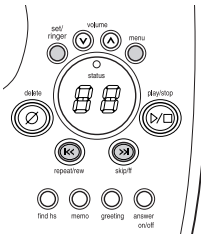

- 1) Press **menu** twice. “Security code” and the current PIN code is announced as it is displayed on the main base.
- 2) Press **skip/ff** or **repeat/rew** until the desired number appears.
- 3) Press **set/ringer** to select the PIN code. You hear a confirmation tone, then the announcement “Security code” and the new PIN code is announced.



The PIN code is set to “80” when you purchase the cordless phone.

Setting the ring time

The ring time setting allows you to set the number of rings the caller hears before your answering system plays the outgoing message. You can set the ring time to answer after two, four, or six rings. Setting **5** (Toll Saver), the answering system picks up after two rings if you have new messages, and after four rings if there are none. This way, if you make a long distance call to check your messages, you can hang up after the second ring to avoid billing charges.

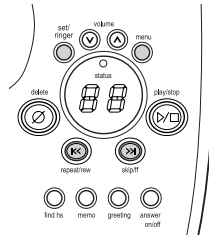

- 1) Press **menu** three times.

You hear "Ring time" and the current ring time ([2] 2, [4] 4, [6] 6, [5] Toll saver), and it is displayed on the main base.

- 2) Press **repeat/rew** or **skip/ff** until the desired ring time appears.
- 3) Press **set/ringer** to select the new ring time. You hear a confirmation tone, then the announcement "Ring time" and the new ring time is announced.

Selecting the message record time

You have three record time options. The options “1 minute” or “4 minutes” set the duration for recording the incoming messages. “**Announce only**” answers the call with the preset greeting or your personal greeting but prevents the caller from leaving a message.

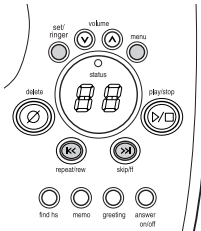

- 1) Press **menu** four times.
You hear “Record time” and the current recording time ([1] 1 minute, [4] 4 minutes, [R] Announce only), and it is displayed on the main base.
- 2) Press **repeat/rew** or **skip/ff** until the desired time appears.
- 3) Press **set/ringer** to select the new recording time. You hear a confirmation tone, then the announcement “Record time” and new recording time is announced.

▼ Announce only feature

The announce only feature plays a prerecorded outgoing message “Hello, no one is available to take your call. Please call again.”, but it will not allow the caller to leave a message. To set “Announce only”, follow the steps above.

To scroll between the prerecorded message or your own personal greeting, press **greeting** when the outgoing message is played. If you want to use your own greeting, you may want to change your greeting to omit the prompt “to leave a message”. Refer to “Recording a personal outgoing message” (Greeting) on page 47.



When using the Announce only feature, you may want to change your outgoing message, if the message prompts the caller to leave a message. The prerecorded message changes automatically.

Setting the Message Alert tone

Message Alert feature lets you know you have new messages by sounding a short beeping tone. If you set the Message Alert to On and when a new message is received, the alert tone will sound every 15 seconds.

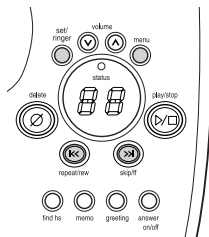

Setting the Message Alert tone to On or Off by using menu key.

1) Press **menu** five times.

You hear the announcement "Message Alert" and the current setting ([*OFF*] Off or [*ON*] On), and it is displayed on the main base.

2) Press **repeat/rew** or **skip/ff** to select.

3) Press **set/ringer** to select the new setting. You hear a confirmation tone, then the announcement "Message Alert" and the current setting you have selected is announced.

When the first new message is received, the beeping tone will begin to sound.

Turning the Message Alert tone Off by pressing any key.

1) To quickly turn Message Alert tone off, **press any key** on the main base unit and the tone will **automatically deactivate**. To reset, go back into the menu setup mode (steps 1 - 3 above.)

Turning the Message Alert tone Off when you're away from your phone.

1) When all **new messages** are played back using the remote playback feature (see page 53) the Message Alert tone will automatically deactivate. The tone will not deactivate until all messages are played back.

Setting Your Outgoing Message (Greeting)

When you receive a call, the answering system automatically plays either a preset message or your own greeting.

▼Preset message

The following message is prerecorded:

“Hello, no one is available to take your call. Please leave a message after the tone.”

 See “Selecting the message record time”, page 45 how to set the announce only feature.

▼Recording a personal outgoing message (Greeting)

1) Press and hold ***greeting***.

You hear the announcement “Record greeting” and a confirmation tone.

[--] flashes on the message counter.

2) Start recording your message. You have 30 seconds, and the message counter starts to count down [30] to [1] every second.

3) When you are finished recording your greeting, press ***greeting*** or ***play/stop***.

You hear a confirmation tone, and then your greeting plays back for you.

▼Choosing between the two outgoing messages

Press ***greeting***. Then press ***greeting*** again when the outgoing message is played. This switches between the prerecorded greeting or the personal greeting. After finishing playing back the message, a confirmation tone is heard.

 To delete the personal Greeting, press ***delete*** during the announcement and the system announces “Greeting has been deleted”.



- You can record a greeting up to 30 seconds long.
- Position yourself as near to the main base as possible and speak clearly when recording your outgoing message.



When you have set the main base ringer to off and the handset is on the main base, you will still hear the ringer from the handset.

Setting the main base ringer volume

You have three ringer options. One allows you to turn the ringer off. The other two are volume levels.

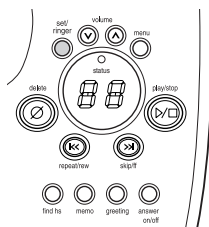

1) Press **set/ringer**.

You hear the ringer at the current volume level ([*H*] High, [*L*] Low, [*OFF*] off) (if you set the main base ringer volume to off, "off" is announced) and it is displayed on the main base.

2) Press **set/ringer** until the desired ringer option appears.

3) The system displayed new ringer volume.

Adjusting the speaker volume level

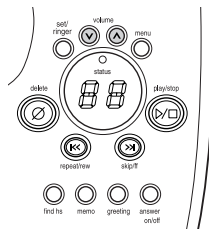

You can adjust the volume of the main base speaker by pressing the **volume** keys on the main base. Press **▲** for louder or **▼** for softer during the main base speaker is being used.

The numbers 0-9 are displayed on the main base indicating the volume levels. 0 being the softest and 9 being the loudest.



When you press **▲** at 9 or **▼** at 0, an error tone sounds.

Using Your Answering System

The message counter displays the number of messages stored in memory. If the display flashes, then there are new messages waiting for you. The flashing number represents the number of new messages, not total messages. The cordless phone is designed to play your new messages first. After you play all your new messages, you can then play your old messages.

note When the answering system is full, *FL* is displayed on the main base, and the system announces “No remaining time”. You should delete some messages so that the system can record new messages. (Refer to “Deleting a message” on page 51.)

Playing your messages

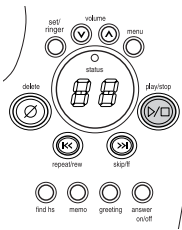

1) Press **play/stop**.

The system announces the number of new and old messages. The main base message counter displays the number of new messages, and the number flashes. The day and time that each message was received is announced after the message is played. The message counter displays the number of current messages stored.

When all new messages have been played, you hear a confirmation tone and an announcement “End of messages”. The system returns to standby.

2) After you have reviewed your new messages, you can play your old messages by again pressing **play/stop**. Once you have listened to a new message, it becomes an old message. The old messages will be played in the order in which they were received.



To stop playing your messages, press **play/stop** again at any time.

Repeating a message

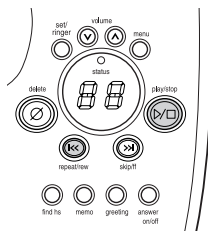

- 1) Press **play/stop** to review your messages. The number of stored messages are announced.
- 2) After a message has played for a few seconds, press **repeat/rew** to replay the message. If you have several messages, press **repeat/rew** repeatedly until you return to the message you want to replay.
- 3) Press **play/stop** at any time to stop reviewing messages and return to standby. The message counter shows the number of messages stored in memory.

*To quickly scroll backwards through a message, press and hold **repeat/rew**.*

Skipping a message

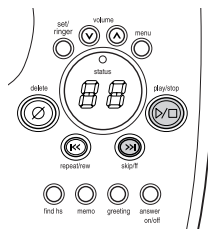

- 1) Press **play/stop** to review your messages. The number of messages is announced.
- 2) Press **skip/ff** at anytime to skip to the next message. Each time **skip/ff** is pressed, the system scans forward one message. If you have several messages, press **skip/ff** to find the message you want to play.
- 3) Press **play/stop** at any time to stop reviewing your messages and return to standby. The message counter shows the number of messages stored in memory.

*To quickly scroll forward through a message, press and hold **skip/ff**.*

Deleting a message

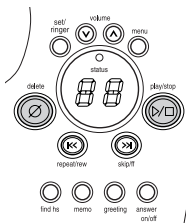

To maintain maximum record time, delete the old messages.

- 1) Press **play/stop** to review your messages.
- 2) Press **delete** anytime during the message to delete.
- 3) You hear a confirmation tone and the message is deleted.

You can also delete all the messages.

- 1) Press **delete**.
You hear a announcement "To delete all messages, press delete again".
- 2) Press **delete** again.
You hear a confirmation tone and all the messages are deleted.

When you try to delete all messages without first listening to your new messages, you hear several short beeps followed by an announcement "Please playback all messages". This protects you from accidentally erasing messages you have not yet reviewed.



When you press **delete**, you are permanently deleting the message. Once deleted, the message cannot be replayed.



- The voice memo function is completely independent of the greeting message.
- The voice memo messages are recorded as incoming messages.
- A recorded conversation is treated as a typical message and will be added to the stored messages.
- When recording a conversation, all handset keys, except **talk/flash**, **select/ch**, **delete/transfer**, volume \wedge/\vee and **end** are disabled. Stop recording if you need to enable any other handset keys.
- Transfer the call also stop recording.

Voice memo

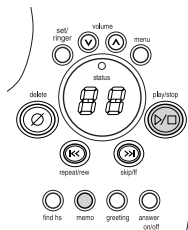

The voice memo function allows the user to record messages (up to 10 minutes).

- 1) Press and hold **memo**.
You hear an announcement “Record memo message” and a confirmation tone. [--] flashes on the message counter.
- 2) Start your recording.
- 3) When you have finished, press **play/stop** or **memo** to stop recording. You hear a confirmation tone and the system returns to standby.

Recording a conversation

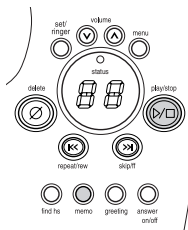

You can record up to 10 minutes of conversation while you are using your phone.

- 1) During a conversation from the handset, press and hold **memo**. The unit begins recording and [--] flashes on the message counter.
A beep that can be heard by both parties, sounds during recording.



If you receive a call waiting tone while recording a conversation, press **talk/flash** to accept the waiting call. The recording feature continues recording the new call. The original call is put on hold.

- 2) To stop recording, press **play/stop** or **memo**.

Remote access away from home

You can operate your answering system from a remote location using any touch-tone telephone. Use this function to check for recorded messages, to play or delete messages, even to record a new greeting message.

- 1) Call your telephone number.
- 2) During the greeting message, press # and enter your PIN code.
(See "Setting a Personal Security Code", page 43).
- 3) The answering system announces the current time and the number of messages stored in memory. Then you hear "To play incoming messages, press pound two. For help, press pound zero".
- 4) You may continue to listen to the Help Guidance, or you may select a command from the following chart:

Command	Function
# then 1	Repeat a Message
# then 2	Playing Incoming Messages
# then 3	Skipping a Message
# then 4	Deleting a Message
# then 5	Stop Operation
# then 6	Answering System On
# then 7	Memo Record/Stop*
# then 8	Greeting Message Record/Stop*
# then 9	Answer System Off
# then 0	Help Guidance

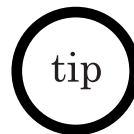

For your convenience remote operation cards are provided for you to use while away from home (located after the index page).



You must enter a command within 15 seconds of entering command waiting mode or the answering system automatically hangs up and returns to standby.

- * For Memo Record and Greeting Message Record function, the first time you enter the corresponding command, it starts the Recording function. If you want to stop the recording, enter the command again.
- 5) After all of the Help Guidance prompts have played, you hear intermittent beeps indicating that the system is in the command waiting mode. You may enter another command at this time from the chart.
- 6) When you are finished, hang up to exit the system. The answering system automatically returns to standby.

Turn on the answering system remotely

If you have forgotten to turn on your answering system, you can turn it on remotely from any touch-tone telephone.

- 1) Call your telephone number.
- 2) Wait ten rings until the system answers. You hear a beep.
- 3) Press **#** and then enter your PIN code. The answering system announces the number of messages stored in memory. You hear "To play incoming messages, press pound two. For help, press pound zero".
- 4) Press **#** then **6** to turn the answering system On. You hear the outgoing message and a confirmation tone.
- 5) Hang up the phone and subsequent calls will be answered by the system.

Changing the Digital Security Code

The digital security code is an identification code used to connect the handset and the main base unit. This cordless telephone uses a digital security code to prevent unauthorized access to your base unit. This security code prevents other cordless handset from making calls through your base unit. Normally, setting the code is not necessary.

The first time you charge your handset, the security code is automatically set.

In the rare situation that you suspect another cordless telephone is using the same security code, you can change the code.

- 1) Remove the handset from the main base unit. Press and hold ***find handset*** on the main base.
- 2) The handset begins emitting a paging sound. While holding ***find handset***, place the handset on the main base unit. The paging sound stops.
Leave the handset on the main base for more than 3 seconds. A new random security code is set.

Installing the Beltclip

To attach the beltclip

Insert the beltclip into the holes on each side of the handset. Press down until it clicks.

To remove the beltclip

Pull both sides of the beltclip to release the tabs from the holes.

Headset Installation

Your phone may be used with an optional headset, the Uniden HS910.

To use this feature, insert headset plug into the headset jack.

Your phone is ready for hands-free conversations.

(Headset may be purchased by calling the Uniden Parts Department or visiting the web site. See Page 7.)

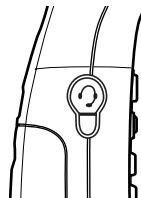

- You can change the phone's digital security code on either handset. However, you must re-register the other handset (not used to change the digital security code) back to the main base unit. See registration on page 12.
- If the handset battery pack is completely discharged or the battery pack is removed, the digital security code will be lost. If this happens, a new security code is set automatically next time the battery pack is charged in the main base.

Note on Power Sources

Battery replacement and handling

When the operating time becomes short, even after a battery is recharged, please replace the battery.

With normal usage, your battery should last about one year.

Please contact your place of purchase or the Uniden Parts Department for a replacement battery.

Warning: To avoid the risk of personal injury or property damage from fire or electrical shock, only use the Uniden battery model and Uniden adapter model specifically designated for this product.

Power Failure

During the period that the power is off, you will not be able to make or receive calls with the telephone.

Caution

- Use only specified Uniden battery pack (BT-905).
- Do not remove the battery from the handset to charge it.
- Never throw the battery into a fire, disassemble it, or heat it.
- Do not remove or damage the battery casing.

Maintenance

When slightly dirty

Wipe with a soft, dry cloth.

When very dirty

Wipe with a soft cloth that has been dampened with diluted, neutral detergent.

Dry with a dry cloth.

When the charging terminals become dirty

Wipe with a dry cloth or a pencil eraser, if necessary.

(See page 10 for the location of charging terminals.)

Caution

Do not use paint thinner, benzene, alcohol, or other chemical products. Doing so may discolor the surface of the telephone and damage the finish.

Troubleshooting

If your phone is not performing to your expectations, please try these simple steps first.

Symptom	Suggestion
The status LED or charge LED won't illuminate when the handset is placed in the main base or charging cradle.	<ul style="list-style-type: none"> • Make sure the AC adapters are plugged into each charging cradle and wall outlet. • Make sure both handsets are properly seated in each charging cradle. • Make sure the charging contacts on both handsets and charging cradles are clean.
The audio sounds weak and/or scratchy.	<ul style="list-style-type: none"> • Make sure that the main base antenna is in a vertical position. • Move the handset and/or base to a different location away from metal objects or appliances and try again. • Press select/channel to help eliminate background noise. • Make sure that you are not too far from the main base.
Can't make or receive calls.	<ul style="list-style-type: none"> • Check both ends of the main base telephone line cord. • Make sure the AC adapter is plugged into the main base and wall outlet. • Disconnect the AC adapter for a few minutes, then reconnect it. • Change the digital security code (See page 55). • Make sure that you are not too far from the main base.
The Caller ID does not display.	<ul style="list-style-type: none"> • The handset was picked up before the second ring. • The call was placed through a switch board. • Call your local telephone company to verify your Caller ID service is current.
The handset doesn't ring or receive a page.	<ul style="list-style-type: none"> • Re-register both handsets (See page 12). • The battery pack may be weak. Charge the battery for 15-20 hours. • The handset may be too far away from the main base unit. • Place the main base unit away from appliances or metal objects. • Make sure the volume setting is not Ringer off.

Symptom	Suggestion
Severe noise interference.	<ul style="list-style-type: none"> • Keep the handset away from microwave ovens, computers, remote control toys, wireless microphones, alarm systems, intercoms, room monitors, fluorescent lights, and electrical appliances. • Move to another location or turn off the source of interference.
Handset No.1 or No.2 not working.	<ul style="list-style-type: none"> • Make sure the battery pack is connected to the handset and fully charged. • Place one handset at a time on the main base for 5 seconds each.
"Unavailable" message is displayed on the LCD screen of the handset.	<ul style="list-style-type: none"> • Make sure the other handset is not already in use. Both handsets cannot be in talk mode at the same time. • Place the handset for at least 5 seconds to re-register to the main base. • Make sure the handset is not too far from the main base when trying to use.
The handset doesn't communicate with the main base or the other handset.	<ul style="list-style-type: none"> • Re-register both handsets (See page 12). • Make sure that you registered the extra handset.
No 3-way conversation.	<ul style="list-style-type: none"> • Only one handset at a time can talk with an outside caller. To allow the other handset to talk to the caller, transfer the call.
"Low Battery" message is displayed on the LCD screen.	<ul style="list-style-type: none"> • Place the handset back in either cradle to recharge over night.
The answering system does not work.	<ul style="list-style-type: none"> • Make sure the main base unit is plugged in. • Make sure the answering system is turned on.

Symptom	Suggestion
The answering system does not answer calls.	<ul style="list-style-type: none"> • Set the record time to either the one minute or four minute option. • The memory may be full. Delete some or all of the saved messages.
Messages are incomplete.	<ul style="list-style-type: none"> • The incoming messages may be too long. Remind callers to leave a brief message. • The memory may be full. Delete some or all of the saved messages.
No sound on the main base unit speaker during call monitoring or message playback.	<ul style="list-style-type: none"> • Adjust the speaker volume on the main base unit.
Cannot access remote call-in features from another touch-tone phone.	<ul style="list-style-type: none"> • Make sure you're using the correct PIN code. • Make sure that the touch-tone phone you're using can transmit the tone for at least two seconds. If it cannot, you may have to use another phone to access your messages.
If you still have a problem.	<ul style="list-style-type: none"> • Call our customer hotline at 1-800-297-1023.

General Information

The phone complies with FCC Parts 15 and 68.

Operating temperature: -10° to 50°C (+32°F to +122°F)

AC Adapter Information

AC Adapter part number: AD-420
Input Voltage: 120V AC 60Hz
Output Voltage: 9V DC 350 mA

Battery Information

Battery part number: BT-905
Capacity: 600 mAH, 3.6V
Battery use time (per charge)
From fully charged
Talk mode duration: 7 hours
Standby mode duration: 10 days



- **To avoid damage to the phone use only Uniden AD-420 and BT-905 with your phone.**
- If the handset is left off of the main base, the actual Talk mode duration will be reduced respective to the amount of time the handset is off the main base.

Recharge your phone on a regular basis by returning the handset to the main base after each phone call. When the operating time becomes short, even after the battery is recharged, please replace the battery. With normal usage, the battery should last about one year.

A replacement Uniden adapter and battery may be purchased at your local Uniden dealer or by contacting the Uniden Parts Department (800) 554-3988. Hours are from 7:00 a.m. to 5:00 p.m. Central Time, Monday through Friday. We can also be reached on the web at www.uniden.com

Specifications, features, and availability of optional accessories are all subject to change without prior notice.

Precautions!

Before you read anything else, please observe the following:

Warning!

Uniden America Corporation DOES NOT represent this unit to be water-proof. To reduce the risk of fire, electrical shock, or damage to the unit, DO NOT expose this unit to rain or moisture.

Rechargeable Nickel-Cadmium Battery Warning

- This equipment contains a rechargeable nickel-cadmium battery.
- Cadmium is a chemical known to the State of California to cause cancer.
- The rechargeable nickel-cadmium battery contained in this equipment may explode if disposed of in a fire.
- **Do not** short-circuit the battery.
- Do not charge the rechargeable nickel-cadmium battery used in this equipment in any charger other than the one designed to charge this battery as specified in the owner's manual. Using another charger may damage the battery or cause the battery to explode.

Rechargeable Nickel-Cadmium Batteries Must Be Recycled or Disposed of Properly

- Uniden voluntarily participates in an RBRC® industry program to collect and recycle nickel-cadmium batteries at the end of their useful life, when taken out of service within the United States. The RBRC® program provides a convenient alternative to placing used nickel-cadmium batteries into the trash or municipal waste stream, which is illegal in some areas.
- Through the RBRC® program, Uniden makes it easy for you to drop off the used battery at local retailers of replacement nickel-cadmium batteries. You may also contact your local recycling center for information on where to return the used battery. Please call 1-800-8-BATTERY for information on Ni-Cd battery recycling in your area. Uniden's involvement in this program is part of its commitment to protecting our environment and conserving natural resources.
- RBRC® is a registered trademark of the Rechargeable Battery Recycling Corporation.



The exclamation point within an equilateral triangle is intended to alert the user to the presence of important operating and maintenance (servicing) instructions in the literature accompanying the appliance.

Important Safety Instructions

When using your telephone equipment, these basic safety precautions should always be followed to reduce the risk of fire, electrical shock, and injury to persons:

1. Read and understand all instructions.
2. Follow all warnings and instructions marked on the product.
3. Unplug this product from the wall outlet before cleaning. Use a dry

cloth for cleaning without liquid or aerosol cleaners.

4. Do not use this product near water; for example, near a bathtub, wash bowl, kitchen sink or laundry tub, in a wet basement, or near a swimming pool.
5. Do not place this product on an unstable cart, stand, or table. The telephone may fall, causing serious damage to the unit.
6. Slots and openings in the cabinet and the back or bottom are provided for ventilation. To protect the product from overheating, these openings must not be blocked or covered. This product should never be placed near or over a radiator or heat register. This product should not be placed in a built-in installation unless proper ventilation is provided.
7. This product should be operated only from the type of power source indicated on the marking label. If you are not sure of the type of power supply to your home, consult your dealer or local power company.
8. Do not allow anything to rest on the power cord. Do not locate this product where the cord will be damaged by persons walking on it.
9. Do not overload wall outlets and extension cords, as this can result in the risk of fire or electrical shock.
10. Never push objects of any kind into this product through cabinet slots. As they may touch dangerous voltage points or short out parts that could result in a risk of fire or electric shock. Never spill liquid of any kind on the product.
11. To reduce the risk of electric shock, do not disassemble this product. Take it to qualified service personnel when service or repair work is required. Opening or removing covers may expose you to dangerous voltages or other risks. Incorrect reassembly can cause electric shock when the appliance is subsequently used.
12. Unplug this product from the wall outlet and refer servicing to qualified service personnel under the following conditions:
 - A. When the power supply cord is damaged or frayed.
 - B. If liquid has been spilled into the product.
 - C. If the product has been exposed to rain or water.
 - D. If the product does not operate normally when following the operating instructions. (Adjust only those controls that are covered by the operating instructions. Improper adjustment of other controls may result in damage and will often require extensive repair work by a qualified technician.)
 - E. If the product has been dropped or the cabinet has been damaged.
 - F. If the product exhibits a distinct change in performance.
13. Do not use the telephone to report a gas leak in the vicinity of the leak.

Additional Battery Safety Precautions

Caution! To reduce the risk of fire or injury to persons by the battery, read and follow these instructions:

1. Use only Uniden battery pack specified in the owner's manual.
2. Do not dispose of the battery pack in a fire. The cell may explode. Check the nickel-cadmium battery disposal package insert for disposal instructions.
3. Do not open or mutilate the battery pack. Released electrolyte is corrosive and may cause damage to the eyes or skin. It may be toxic if swallowed.
4. Exercise care in handling the battery in order not to short the bat-

- tery with conducting materials such as rings, bracelets, and keys. The battery or conductor may overheat and cause burns.
5. Charge the battery pack provided with or identified for use with this product only in accordance with the instructions and limitations specified in the owner's manual provided for this product.
6. Observe proper polarity orientation between the battery pack and battery charger.

SAVE THESE INSTRUCTIONS!

Important Electrical Considerations

Unplug all electrical appliances when you know an electrical storm is approaching. Lightning can pass through your household wiring and damage any device connected to it. This phone is no exception.

Warning!

Please do not attempt to unplug any appliance during an electrical storm.

The FCC Wants You To Know

Changes or modifications to this product not expressly approved by Uniden, or operation of this product in any way other than as detailed by the owner's manual, could void your authority to operate this product. The equipment cannot be used on public coin phone service provided by the telephone company. Connection to party line service is subject to state tariffs. (Contact the state public utility commission, public service commission or corporation commission for information.)

Range

Your new phone is designed to achieve the maximum possible range by transmitting and receiving according to the highest specifications set forth by the FCC. We have rated this phone to operate at a maximum distance with the qualification that the range depends upon the environment in which the telephone is used. Many factors limit range, and it would be impossible to include all the variables in our rating. The Maximum Range rating of this phone is meant to be used as a means of comparison against other range claims.

Telephone Line Problems

The FCC has granted the telephone company the right to disconnect service in the event that your phone causes problems on the telephone line. Also, the telephone company may make changes in facilities and services which may affect the operation of your unit. However, your telephone company must give adequate notice in writing prior to such actions to allow you time for making necessary arrangements to continue uninterrupted service.

If you are having trouble with your telephone service, you must first disconnect your phone to determine if it is the cause of your problem. If you determine that it is the cause, you must leave it disconnected until the trouble has been corrected.

Radio Interference

Radio interference may occasionally cause buzzing and humming in your cordless handset, or clicking noises in the base. This interference is caused by external sources such as TV, refrigerator, vacuum cleaner, fluorescent lighting, or electrical storm. Your unit is NOT DEFECTIVE. If these noises continue and are too distracting, please check around your home to see what appliances may be causing the problem. In addition,

we recommend that the base not be plugged into a circuit that also powers a major appliance because of the potential for interference. Be certain that the antenna on the unit is fully extended when needed. In the unlikely event that you consistently hear other voices or distracting transmissions on your phone, you may be receiving radio signals from another cordless telephone or other source of interference. If you cannot eliminate this type of interference, you need to change to a different channel.

Finally, it should be noted that some cordless telephones operate at frequencies that may cause interference to nearby TVs and VCRs. To minimize or prevent such interference, the base of the cordless telephone should not be placed near or on top of a TV or VCR. If interference is experienced, moving the cordless telephone farther away from the TV or VCR will often reduce or eliminate the interference.

More Than One Cordless Telephone

If you want to use more than one cordless telephone in your home, they must operate on different channels. Press the channel key to select a channel that provides the clearest communication.

Cordless Telephone Privacy

Cordless telephones are radio devices. Communications between the handset and base of your cordless telephone are accomplished by means of radio waves which are broadcast over the open airways. Because of the inherent physical properties of radio waves, your communications can be received by radio receiving devices other than your own cordless telephone unit. Consequently, any communications using your cordless telephone may not be private.

Installation Considerations

Selecting a Location

Before choosing a location for your new phone, there are some important guidelines you should consider:

- The location should be close to both a phone jack and continuous power outlet. (A continuous power outlet is an AC outlet which does not have a switch to interrupt its power.)
- Keep the base and handset away from sources of electrical noise such as motors or fluorescent lighting.
- Be sure there is sufficient space to fully extend the base antenna.
- The base can be placed on a desk or tabletop or mounted on a standard telephone wall plate.
- You should charge your new phone for 15-20 hours before completing the installation or using the handset.

Telephone Line Outlets

There are two types of phone outlets:

Modular Jack

Most phone equipment available now uses modular jacks. Phone cords are fitted with a molded plastic connector which plugs into this type of jack. If you do not have modular phone jacks, contact your local telephone company for information about their installation.

Hardwired Jack

Some equipment is wired directly to a phone jack, and these types of installations require a modular jack converter. This type of installation is not difficult; however, you should contact your Uniden telephone dealer or a telephone supply store for advice about the proper adapter or con-

verter for your particular situation.

Connecting the Telephone Cords

Consider these safety guidelines before connecting the telephone cords:

Caution!

- *Never install telephone wiring during a lightning storm.*
- *Never touch uninsulated telephone wires or terminals unless the telephone line has been disconnected.*
- *Use caution when installing or modifying telephone lines.*

Applying Power to the Base

This phone requires an AC outlet, without a switch to interrupt power, and the included AC adapter. To relieve strain on the DC plug when the phone is placed on a desk or table, wrap the power cord around the strain relief notch on the bottom of the base.

NOTE:

Place the power cord so that it does not create a trip hazard, or where it could become chafed and create a fire or other electrical hazards.

Adapter Safety Features

If the AC adapter furnished with this phone has a polarized line plug (a plug having one blade wider than the other), this plug will fit into the power outlet only one way. If you are unable to insert the plug fully into the outlet, try reversing the plug.

Do not alter the shape of the blades of the polarized plug!

NOTE:

If you cannot plug the AC adapter into the outlet, contact someone about replacing the outlet.

Plug the AC Adapter into a standard 120 VAC wall outlet.

Do not use an outlet controlled by a wall switch.



Use only the Uniden AC Adapter supplied with this phone.

One Year Limited Warranty

Important: Evidence of original purchase is required for warranty service.

WARRANTOR: UNIDEN AMERICA CORPORATION ("Uniden")

ELEMENTS OF WARRANTY: Uniden warrants, for one year, to the original retail owner, this Uniden Product to be free from defects in materials and craftsmanship with only the limitations or exclusions set out below.

WARRANTY DURATION: This warranty to the original user shall terminate and be of no further effect 12 months after the date of original retail sale. The warranty is invalid if the Product is (A) damaged or not maintained as reasonable or necessary, (B) modified, altered, or used as part of any conversion kits, subassemblies, or any configurations not sold by Uniden, (C) improperly installed, (D) serviced or repaired by someone other than an authorized Uniden service center for a defect or malfunction covered by this warranty, (E) used in any conjunction with equipment or parts or as part of any system not manufactured by Uniden, or (F) installed or programmed by anyone other than as detailed by the owner's manual for this product.

STATEMENT OF REMEDY: In the event that the product does not conform

to this warranty at any time while this warranty is in effect, warrantor will either, at its option, repair or replace the defective unit and return it to you without charge for parts, service, or any other cost (except shipping and handling) incurred by warrantor or its representatives in connection with the performance of this warranty. Warrantor, at its option, may replace the unit with a new or refurbished unit. THE LIMITED WARRANTY SET FORTH ABOVE IS THE SOLE AND ENTIRE WARRANTY PERTAINING TO THE PRODUCT AND IS IN LIEU OF AND EXCLUDES ALL OTHER WARRANTIES OF ANY NATURE WHATSOEVER, WHETHER EXPRESS, IMPLIED OR ARISING BY OPERATION OF LAW, INCLUDING, BUT NOT LIMITED TO ANY IMPLIED WARRANTIES OF MERCHANTABILITY OR FITNESS FOR A PARTICULAR PURPOSE. THIS WARRANTY DOES NOT COVER OR PROVIDE FOR THE REIMBURSEMENT OR PAYMENT OF INCIDENTAL OR CONSEQUENTIAL DAMAGES. Some states do not allow this exclusion or limitation of incidental or consequential damages so the above limitation or exclusion may not apply to you.

LEGAL REMEDIES: This warranty gives you specific legal rights, and you may also have other rights which vary from state to state. This warranty is void outside the United States of America.

PROCEDURE FOR OBTAINING PERFORMANCE OF WARRANTY: If, after following the instructions in the owner's manual you are certain that the Product is defective, pack the Product carefully (preferably in its original packaging). The Product should include all parts and accessories originally packaged with the Product. Include evidence of original purchase and a note describing the defect that has caused you to return it. The Product should be shipped freight prepaid, by traceable means, to warrantor at:

Uniden America Corporation

Parts and Service Division

4700 Amon Carter Blvd, Fort Worth, TX 76155

(800) 297-1023, 8 a.m. to 5 p.m. Central, Monday through Friday

I.C. Notice

TERMINAL EQUIPMENT

NOTICE: This equipment meets the applicable Industry Canada Terminal Equipment Technical Specifications. This is confirmed by the registration number. The abbreviation, IC, before the registration number signifies that registration was performed based on a Declaration of Conformity indicating that Industry Canada technical specifications were met. It does not imply that Industry Canada approved the equipment.

NOTICE: The Ringer Equivalence Number (REN) for this terminal equipment is marked on the equipment itself. The REN assigned to each terminal equipment provides an indication of the maximum number of terminals allowed to be connected to a telephone interface. The termination on an interface may consist of any combination of devices subject only to the requirement that the sum of the Ringer Equivalence Numbers of all the devices does not exceed five.

RADIO EQUIPMENT

The term “IC:” before the radio certification number only signifies that Industry Canada technical specifications were met.

Operation is subject to the following two conditions: (1) this device may not cause interference, and (2) this device must accept any interference, including interference that may cause undesired operation of the device. “Privacy of communications may not be ensured when using this telephone”.

Index

- A**
AC adapter information 60
Announce only feature 45
Answering system
 Deleting a message 51
 Playing a message 49
 Recording a conversation 52
 Remote access 53
 Repeating a message 50
 Skipping a message 50
 Turning on/off 41
- B**
Base location 8
Battery pack
 Information 60
 Install 9
 Maintenance 10, 56
 Preparing and charging 11
 Replacement and handling 56
Beltclip installation 55
- C**
Caller ID
Caller ID service 34
 Call Waiting 22
 Deleting 36
 Setting Caller ID options 16
 Using 38
 Viewing 35
Call transfer feature 13
Call waiting 22
Chain dialing 28
Channel 22
- Charging the battery pack 11
Cleaning battery contacts 10
Clock 42
Connect the main base unit 11
Controls and functions 4
- D**
Dial mode 18
Digital security code 55
- E, F, G, H, I, J, K, L**
Earpiece volume 20
Extra handset 12
General information (Specification) 60
Greeting 47
Headset installation 55
I.C. Notice 63
Interference 22
- M, N, O, P, Q**
Maintenance 56
Making a call 19
Memory dialing
 Editing a stored name
 and/or phone number 29
 Erasing a stored name
 and phone number 31
 Making calls with memory dialing 27
 Storing phone
 numbers and names 23
Menu mode 41
Message alert 46
Mounting on a wall 14
Outgoing message 47
Package contents 7
- Page 22
Personal security code (PIN code) . 43
Precautions 61
Quick reference guide 3
- R**
Receiving a call 19
Recording time 45
Redial 21
Remote access 53
Repeating 50
Ringer volume
 Handset 20
 Main Base 48
Ring time 44
RocketDial 32
- S**
Setting menu options 16
Setting up the Phone 8
Skipping 50
Storing phone number 23
- T, U**
Tone 21
Traveling out-of-range 21
Troubleshooting 57
- V, W, X, Y, Z**
Voice memo 52
Volume control 20, 48
Wall mounting 14
Warranty 62

Remote Operation Card

C U T

REMOTE OPERATION CARD

Uniden
DXAI388-2

Remote access away from home

Turn on the answering system remotely

1. Call your phone number from a touch-tone phone.
2. During the outgoing message, press # and enter your PIN code. The answering system announces the number of messages stored in memory and the help guidance. The phone stands by for you to enter a command.
3. To quit, hang up the phone.

1. Call your phone and let it ring 10 times until it answers.
2. Enter your PIN code.
3. Press # then 5 to stop the announcement.
4. Press # then 6 to turn the answering system on.

C U T

REMOTE OPERATION CARD

Uniden
DXAI388-2

Remote access away from home

Turn on the answering system remotely

1. Call your phone number from a touch-tone phone.
2. During the outgoing message, press # and enter your PIN code. The answering system announces the number of messages stored in memory and the help guidance. The phone stands by for you to enter a command.
3. To quit, hang up the phone.

1. Call your phone and let it ring 10 times until it answers.
2. Enter your PIN code.
3. Press # then 5 to stop the announcement.
4. Press # then 6 to turn the answering system on.

C U T

REMOTE OPERATION CARD

Uniden
DXAI388-2

Remote access away from home

Turn on the answering system remotely

1. Call your phone number from a touch-tone phone.
2. During the outgoing message, press # and enter your PIN code. The answering system announces the number of messages stored in memory and the help guidance. The phone stands by for you to enter a command.
3. To quit, hang up the phone.

1. Call your phone and let it ring 10 times until it answers.
2. Enter your PIN code.
3. Press # then 5 to stop the announcement.
4. Press # then 6 to turn the answering system on.

C U T

REMOTE OPERATION CARD

Uniden
DXAI388-2

Remote access away from home

Turn on the answering system remotely

1. Call your phone number from a touch-tone phone.
2. During the outgoing message, press # and enter your PIN code. The answering system announces the number of messages stored in memory and the help guidance. The phone stands by for you to enter a command.
3. To quit, hang up the phone.

1. Call your phone and let it ring 10 times until it answers.
2. Enter your PIN code.
3. Press # then 5 to stop the announcement.
4. Press # then 6 to turn the answering system on.

Remote Operation Card

C U T

Task	Key
Repeat a Message	# 1
Playing Incoming Messages	# 2
Skipping a Message	# 3
Deleting a Message	# 4
Stop Operation	# 5
Answering System On	# 6
Memo Record/Stop	# 7
Greeting Message Record/Stop	# 8
Answer System Off	# 9
Help Guidance	# 0

C U T

Task	Key
Repeat a Message	# 1
Playing Incoming Messages	# 2
Skipping a Message	# 3
Deleting a Message	# 4
Stop Operation	# 5
Answering System On	# 6
Memo Record/Stop	# 7
Greeting Message Record/Stop	# 8
Answer System Off	# 9
Help Guidance	# 0

C U T

Task	Key
Repeat a Message	# 1
Playing Incoming Messages	# 2
Skipping a Message	# 3
Deleting a Message	# 4
Stop Operation	# 5
Answering System On	# 6
Memo Record/Stop	# 7
Greeting Message Record/Stop	# 8
Answer System Off	# 9
Help Guidance	# 0

C U T

Task	Key
Repeat a Message	# 1
Playing Incoming Messages	# 2
Skipping a Message	# 3
Deleting a Message	# 4
Stop Operation	# 5
Answering System On	# 6
Memo Record/Stop	# 7
Greeting Message Record/Stop	# 8
Answer System Off	# 9
Help Guidance	# 0

MEMO

MEMO

At Uniden, we'll take care of you!

If you need any assistance with this product, please call our Customer Hotline at

1-800-297-1023

PLEASE DO NOT RETURN THIS PRODUCT TO THE PLACE OF PURCHASE.

Our Uniden representatives will be happy to help you with any matters regarding the operation of this unit, available accessories, or any other related matters.

Thank you for purchasing a Uniden product.

Hours: M-F 8:00 AM to 5:00 PM CST.



For information on the accessibility features of this product, please call

1-800-874-9314 (V/TTY)

The Uniden logo is displayed in a bold, black, sans-serif font. The letter 'i' in 'Uniden' has a distinctive dot that is a small circle. A registered trademark symbol (®) is located at the top right of the 'n'.

May be covered under one or more of the following U.S. patents:

4,511,761	4,523,058	4,595,795	4,797,916	5,381,460	5,426,690
5,434,905	5,491,745	5,533,010	5,543,605	5,574,727	5,581,598
5,650,790	5,660,269	5,661,780	5,663,981	5,671,248	5,696,471
5,717,312	5,732,355	5,754,407	5,758,289	5,768,345	5,787,356
5,794,152	5,801,466	5,825,161	5,838,721	5,864,619	5,893,034
5,912,968	5,915,227	5,929,598	5,930,720	5,960,358	5,987,330
6,011,281	6,070,082	6,125,277	6,253,088		

©2002 Uniden America Corporation, Fort Worth, Texas
Custom manufactured in China.
Contains additional foreign articles.

UCZZO1366ZZ